

How Acoustic Camera Measurements can help to increase the Acceptance of Wind Turbines

Michael KERSCHER¹; Benjamin VONRHEIN¹
Prof. Dr. Friedrich UEBERLE²; Dr. Dagmar ROKITA²

1 gfai tech GmbH, Volmerstrasse 3, 12489 Berlin, Germany

Tel.: +49 30 814563-750; Fax.: +49 30 814563-755

kerscher@gfaitech.de; vonrhein@gfaitech.de

2 Hochschule für Angewandte Wissenschaften Hamburg, Ulmenliet 20, 21033 Hamburg,
Germany; Tel.: +49 40 42875-6291; Fax.: +49 40 42875-6499

friedrich.ueberle@haw-hamburg.de; dagmar.rokita@haw-hamburg.de

ABSTRACT

This paper introduces the X-Eptance project of the HAW Hamburg with the goal of creating a wind turbine sound database as a basis for virtual reality simulations of wind parks. This should give residents the chance to get tangible information about the planned wind park in advance with the objective to take away their fears by creating objectivity and to increase acceptance.

Also the basic properties and functionalities of sound source localization using beamforming and the Acoustic Camera are explained in this paper. With this acoustic measurement method it is easy to record, identify and localize sound sources on wind turbines. This information can be used to create a wind turbine sound database, which can be used for the auralization of planned wind parks, as well as a set of reference sounds for the monitoring of wind turbine condition.

Keywords: Wind Turbine Sound, Measurement, Acoustics, Acoustic Camera, Acceptance, Environment, Virtual Reality, Auralization, Condition Monitoring

1. INTRODUCTION

Renewable energies are mandatory to minimize the environmental stress on the planet by a growing population. Wind energy is one big source which is available almost anytime all over the world regardless of temperatures and duration of sunshine. Although the acceptance of this kind of energy is quite widespread, the generation of energy also is accompanied by noise. This adds up to other environmental and man-made noise and frequently leads to skepticism against the installation of wind parks. Wind turbines produce sound at various source locations, e.g. the blades, gears, brakes etc.

Thus the rating of acoustic emissions becomes more and more significant in the field of environmental engineering and the design and evaluation of wind energy plants. A very powerful and comprehensive tool is a measurement with the Acoustic Camera, a special multichannel array of measurement microphones. Applying beamforming algorithms it is possible to localize sound sources. By calculating and compensating the time delays between the sound sources and all the individual microphones and summing up their levels, the sound pressure for individual source locations can be calculated and be depicted in an acoustic map: Sound becomes visible!

This method can be used in any scientific or engineering field, where acoustic properties are of interest.

This project combines measurement and scientific expertise. It is the basis of future work in the form of a database of environmental noise, which can help to increase the acceptance of renewable energy wind park projects and to lower noise emissions from wind parks.

2. X-EPTANCE: THE RENEWABLE ENERGY ACCEPTANCE RESEARCH PROJECTS

X-Eptance is part of a project (X-Energy) of the Competence Center for Renewable Energies (CC4E) at the HAW Hamburg (University of Applied Sciences), funded by the German Research Fund and starting in 2017. In X-Energy, multiple aspects of renewable energies, in particular wind turbine research, energy storage, conversion and distribution as well as environmental aspects are covered by groups of researchers from several departments of the HAW.

The particular goals of X-Eptance are the improvement of public acceptance of renewable energy wind park projects. Two major issues are addressed: The protection of resident animals, in particular bats, and the reduction of noise annoyance.

2.1 Realistic simulation of wind park projects

One of the big issues in the planning of wind parks is to gain the acceptance of residents in the neighborhood of the wind turbines. Although a large set of regulations are in place in many countries, there is still a lack of tangible information regarding the potential change of the sound

scape due to potential additional noise from the wind park. Most laypersons may not be able to envision these changes from looking at noise maps, which are calculated and displayed as part of the application process from standardized wind turbine measurements [1].

In order to improve this situation, both visual as well as acoustical changes of the environment shall be presented to interested persons by using up-to-date virtual reality technology [2]. During the course of the project, both augmented reality 3D visualization and Surround auralization is developed. The simulations are based on noise maps, which should include detailed information on soil structure and vegetation. Further, typical distribution of wind data (direction, strength, occurrences) which are anyway required in the planning process, shall be used. All information is used to calculate the contribution of each planned wind turbine in the form of a set of filter parameters, which allow to shape the sound of a wind turbine of the planned type, at the actual place of the listening person in real-time. This position is tracked by using GPS and other positional sensor data of the listener.

The actual sound of each wind turbine is then simulated by applying the filters to sound from a wind turbine sound data base. Head related transfer functions (HRTF) are used to increase the perception of the correct spatial position of the turbine [3]. All contributions from the planned wind turbines are added up, together with the actual environmental noise, picked up by a set of microphones and presented to the listener using calibrated headphones.

3. THE WIND TURBINE SOUND DATABASE

The key element for the auralization is a wind turbine sound database of a large variety of turbine types. In the first stage of the project, sounds of each turbine at different wind speed and from several aspect angles up- and downwind are recorded at positions close to the turbines. These sounds can be validated both by comparing their sound levels to the data sheets given by manufacturers, but more important by a comparison study of a sufficient set of test persons.

In a later stage, these reference sounds might also be produced by doing complete simulations of the wind turbine sound components, which is in the scope of another X-Energy project.

In order to gain recordings of single wind turbines without disturbing environmental noise components, a very selective recording technology is needed, which is given by using array systems like the Acoustic Camera described below.

Besides the auralization, the data base can also be used as a reference for condition monitoring of wind turbines. By appropriate comparison of actual recordings and the reference sound, mechanical problems of turbines can be diagnosed. Thus, the data base combined with selective on-line measurements also enables wind park operators to optimize their service planning and damage prediction.

4. THE ACOUSTIC CAMERA

The Acoustic Camera is a sophisticated acoustic measurement tool. It consists of an array of several measurement microphones which are placed on a rigid structure following specific design rules, a data acquisition system and a laptop for the analysis.



Figure 1: various microphone arrays [4]

In general the channel count, the microphone positions and form and size of the arrays determine the frequency range for sound localization, the dynamic range, the measurement distance and the localization accuracy. There are different arrays for different tasks. For wind turbine measurements mainly big arrays – like the one in the middle in figure 1 – with a large diameter are used. They are specialized for the localization of rather low-frequency sound at large distances.

The basic algorithm behind the evaluation of the recorded data is the so-called delay-and-sum-beamforming algorithm. It is based on the evaluation of run-time differences from the sound source to the different microphones. A similar concept is at least partially used for sound localization with the human hearing. The run-time delay between the two ears is interpreted by the human brain to locate sound sources in the environment and gives us the information, where a sound is actually coming from.

The Acoustic Camera of course uses way more sensors for this localization task. The microphone data is used to calculate the sound pressure level for a certain position using the following formula:

$$\hat{f}(\mathbf{x}, t) = \frac{1}{M} \sum_{i=1}^M w_i f_i(t - \Delta_i). \quad (1)$$

In (1) f denotes the corresponding sound pressure level for a given time t and a position x on a reference plane and M is the number of microphones. w_i could be used as optional spatial shading weights, but in this case they are simply set to unity, as spatial shading does not occur.

Figure 2 shows the situation more in detail. A sound event reaches a number of microphones (in this case four) placed at different positions x . The sound reaches each microphone at different times, because of the different distances between the sound event and the different microphone positions. Using the speed of sound c the run-time delays τ_i from the source to each microphone can be calculated. So, the sound reaches the second microphone first, then the first, then number three and finally number four. These run-times are equalized by using a set of delays Δ_i . In the next step the delayed microphone signals are summed up, which results in a level that is actually too high. Therefore this level must be divided by the numbers of microphones, in this case four. The end result is then the sound pressure level of the sound event f at the position x and for the time t .

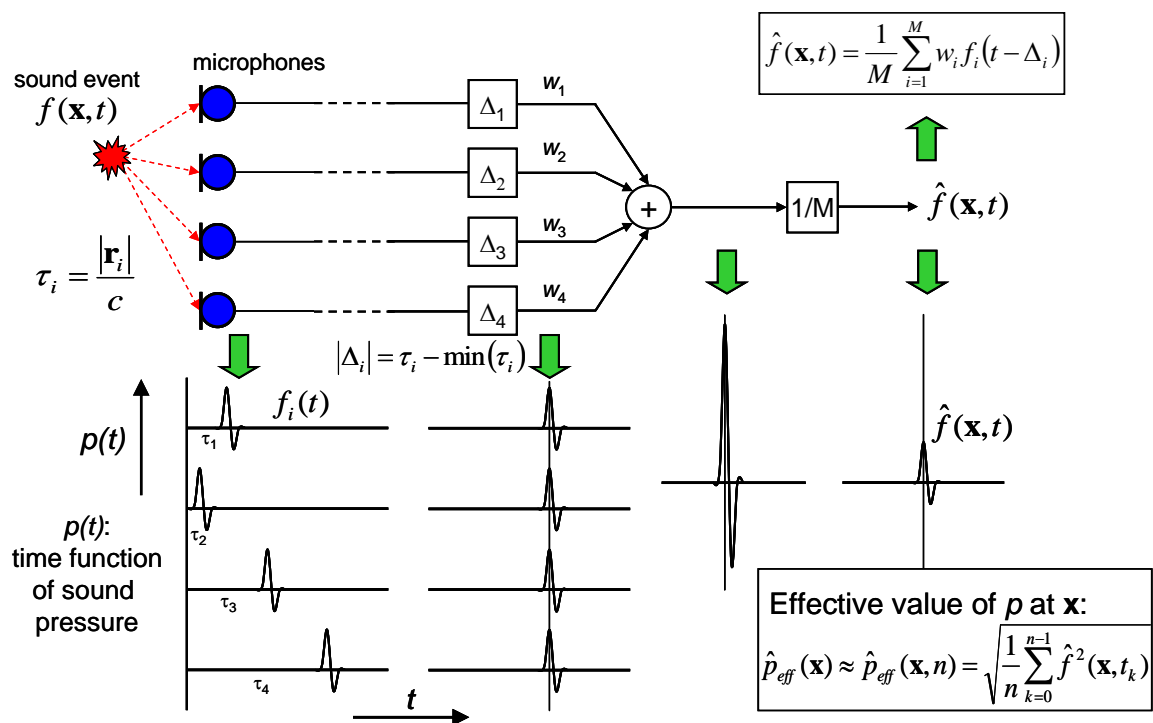

Figure 2: The principle of time-domain beamforming [4]

In the next step this process is applied to a number of picture points in a photo plane, in which the device under test (in this case the wind turbine) is located. Figure 3 shows that to each picture point a corresponding set of distances r_i and run-time delays t_i can be calculated.

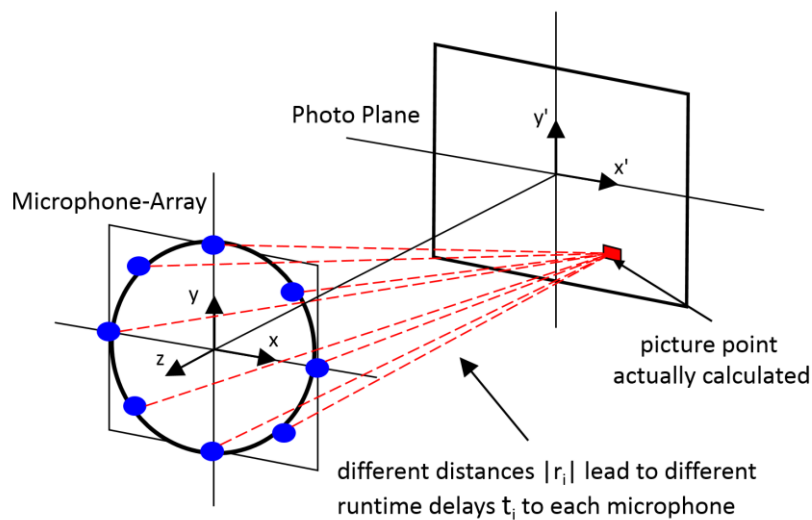

Figure 3: photo plane and microphone plane [4]

Thus, with the delay-and-sum-beamformer a sound pressure level can be determined for all the picture points. Following a given color scale, which defines corresponding colors for certain sound pressure levels, all the picture points are dyed accordingly and the so called acoustic map is created. Finally, this is overlaid with the optical reference picture, which represents the photo plane (figure 4). This end product is then called acoustic picture, in which the colors represent sound pressure levels similar to pictures of heat cameras, where the colors represent temperatures: sound becomes visible!

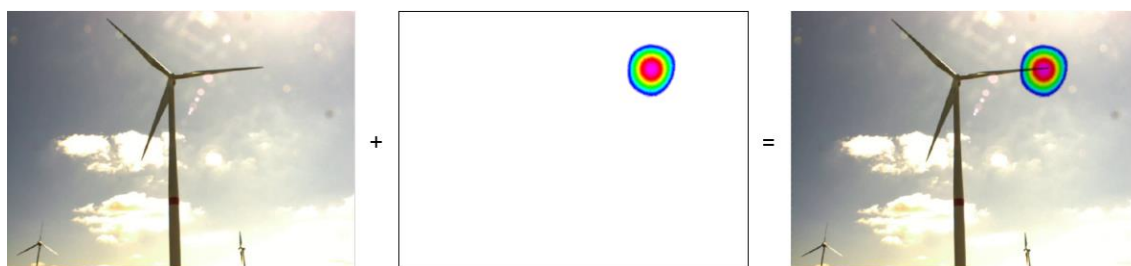

Figure 4: overlay of optic and acoustic picture

5. FIRST RESULTS

The Acoustic Camera is used to record and provide data for the wind turbine sound database. Because of its high accuracy and spatial resolution it is possible to extract various sound sources from the measurements and put them into the database. The measurements will determine, which sources on the wind turbine are actually relevant. Figure 5 shows a standard measurement situation of wind turbines; here in a wind park close to Hamburg, Germany, which the HAW uses

for the evaluations at the moment. For wind turbine measurements rather big arrays are used, which are specialized on low frequencies and far distances. The array is placed in front of the wind turbine in a distance of about 100 to 300 meters, which is shown in figure 5.



Figure 5: Wind turbine measurement in a wind park close to Hamburg

First results reveal, that in many cases the loudest sound source can be found on the blades. Figure 6 shows an acoustic picture of a wind turbine, where the complete frequency range has been taken into account (besides an A-weighting).

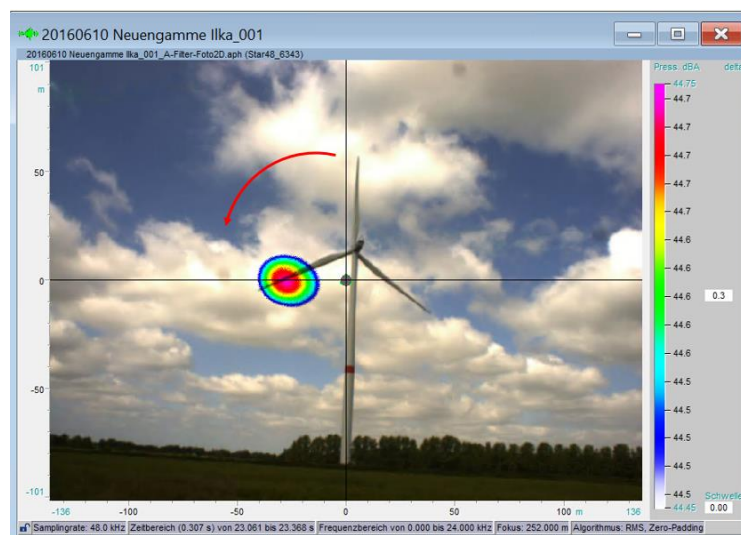

Figure 6: Acoustic picture of a wind turbine. As expected the maximum sound level is perceived from the blade at downward direction close to the blade tip

During recording the measurements, preview noise images are displayed. Detailed analyses can be made afterwards to identify the positions of different sound sources. In Fig. 6 the main source is the blade noise, which occurs at positions close to the tip of the downward blade. Further analysis can comprise filtering of spectral components. In Fig. 7 a source at a higher frequency band (1540 – 4910 Hz) can be shown at the nacelle. Even higher frequency sporadic events can be identified as bird chirrup. As it is also possible to listen selectively into mouse-defined regions in the images by using a “virtual microphone”, the sounds can be identified by ear, which sometimes is very helpful in order to refine the further analysis. In Fig. 8 their position is shown by applying a narrow band filter in the spectrogram, which can be conveniently defined by mouse action on the screen.

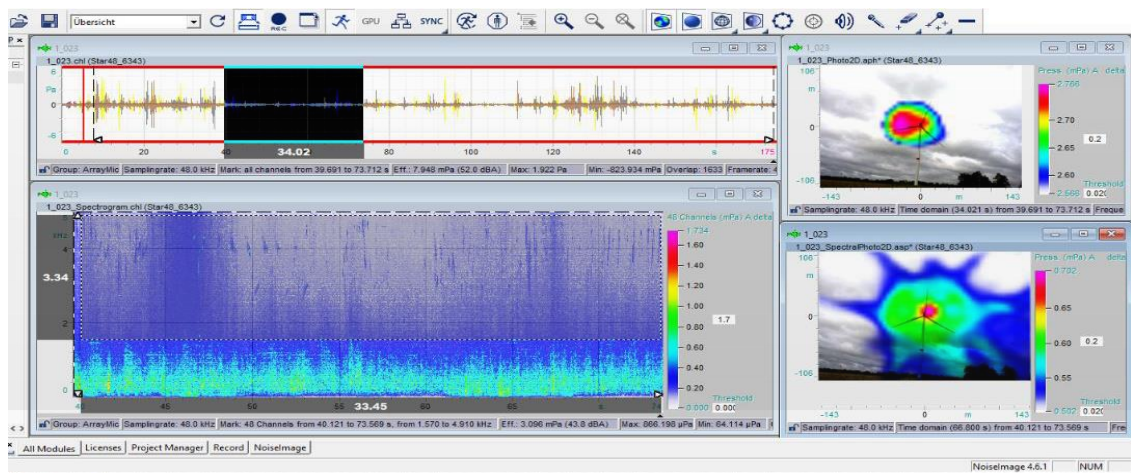

Figure 7: Using advanced software features, it is feasible to increase the selectivity of the display. Here the noise in the frequency range of 1540 – 4910 Hz shows a source position at the nacelle [5].

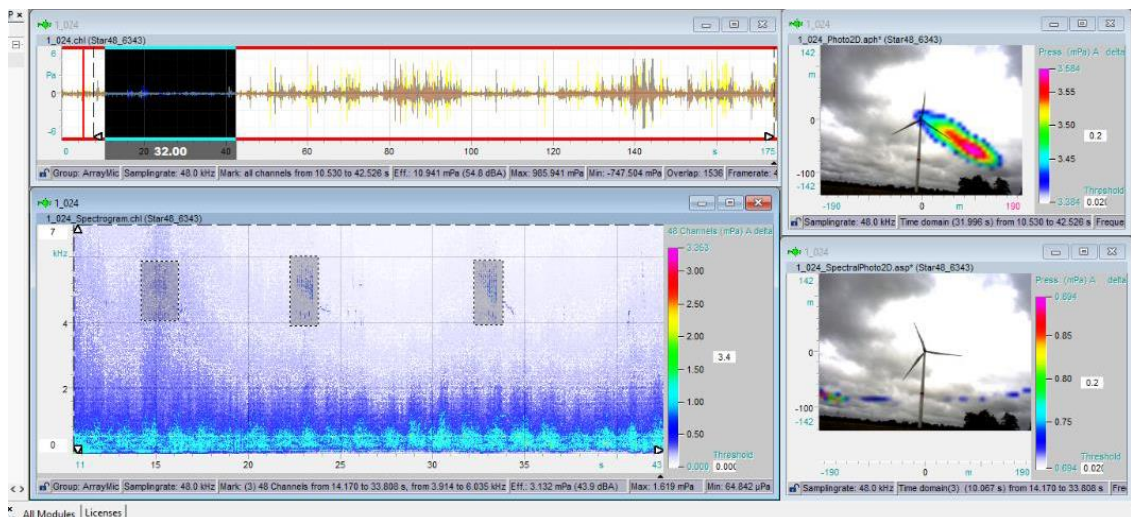

Figure 8: A broadband image (upper right) displays a mix of different sources. Spectral components in the higher kHz range (grey boxes in the spectrogram) can be identified by ear (listening to the time signal) as bird chirrups. The image reconstructed with the same filter settings (lower right) confirms these findings [5].

In addition to the amplitude modulated blade noise, continuous sound, e.g. hum, can be identified easily from a horizontal line in the spectrogram. In the case of Fig. 9 a transformer box at the foot of the wind turbine (Fig. 10) transmits a constant hum at 150 and 560 Hz. Also, frequency modulation of continuous tonal components which are the result of the blade rotation could be seen as corrugated lines.

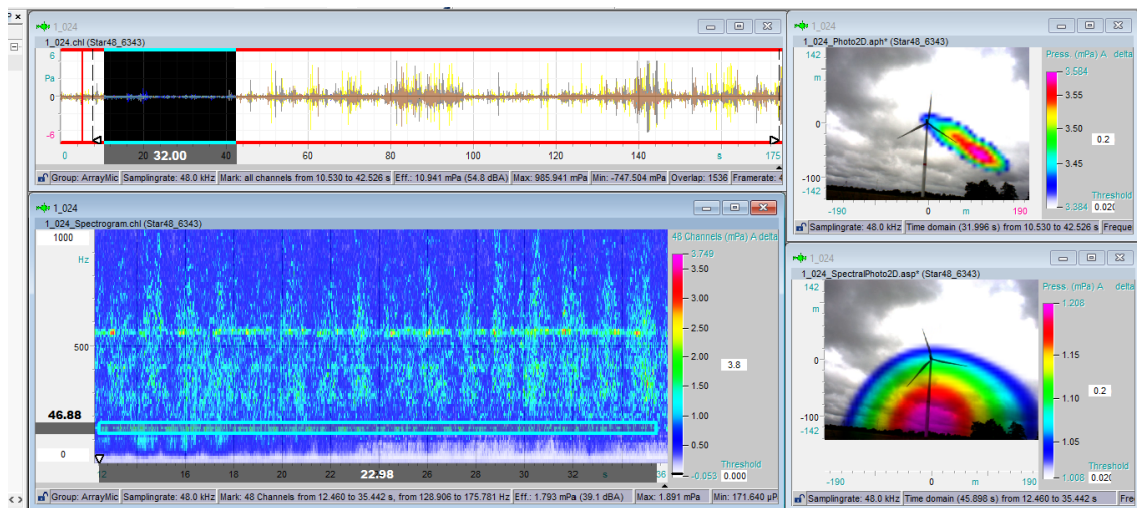

Figure 9: A broadband image (upper right) displays a mix of different sources. Spectral components at 150 Hz and 560 Hz are identified as continuous tones in the spectrogram. After filtering, their source shows at ground level at the left side besides the wind turbine, which is the position of a transformer box (See Fig. 10, red arrow) [5].



Figure 10: View of the transformer box at the foot of the wind turbine (red arrow left) and two wind turbines in the background (yellow arrow right: 404 m from the camera position).

Another very useful feature is the acoustic eraser, which allows for removing louder sources from the image. As shown in Fig. 11, the hum from the transformer and another source at the nacelle have almost the same sound level. By applying the acoustic eraser repeatedly, it is also feasible to measure and display the noise level from wind turbines at a longer distance even if louder sources are in the foreground (Fig. 12)

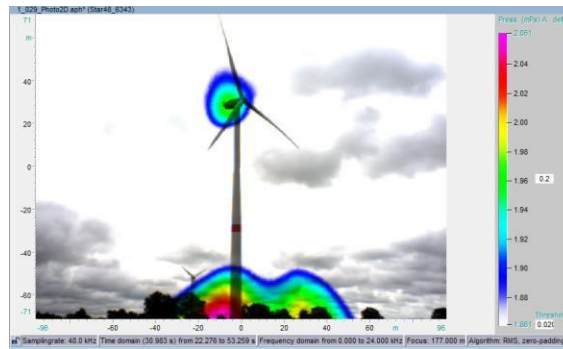

Figure 11: Further analysis using the “acoustic eraser” cancels out louder noise sources (blade noise) and allows for the identification of the position of undertone sources, here: transformer box and nacelle



Figure 12: The wind turbine in the background (404 m apart) is targeted by removing the main blade noise component of the turbine in the foreground (149 m) using the acoustic eraser.

The next step will be the extraction of sound files at the interesting points of the images.

In the future more measurements will be made to fill up the database with as many recordings as possible to profoundly understand, how and where different sounds from a wind turbine are emitted and to collect as much sound recordings as possible to start and optimize the auralization tasks described in the previous chapters.

6. CONCLUSIONS

In the context of the X-Eptance project a wind turbine sound database is created. Using the Acoustic Camera as a measurement tool this database will contain a huge amount of recordings of individual sound emissions of wind turbines. This data can be used as a reference basis for condition and environmental monitoring on the one hand and for the auralization of wind turbine sound on the other hand.

The final aim of the X-Eptance project is to take residents' concerns seriously. The hope is to take away people's fear of wind farms by creating objectivity and transparency. The virtual reality simulation and auralization of wind turbines could be a big step in that direction by giving people tangible information in advance, before the wind park is built. This way it can contribute to an increasing acceptance of new wind park projects and repowering projects in the public.

REFERENCES

- [1] EN 61400-11 Wind turbine generator systems – Part 11: Acoustic noise measurement techniques (IEC 61400-11:1998), CENELEC 1998
- [2] Manyoky, Wissen Hayek, Heutschi, Pieren, Grêt-Regamey: Developing a GIS-Based Visual – Acoustic 3D Simulation for Wind Farm Assessment, ISPRS Int. J. Geo-Inf. 2014, 3, 29 – 48; doi: 10.3390/ijgi3010029
- [3] Navvab, Meyer, Heilmann: Application of the head related transfer functions in room acoustics design using beamforming, Proceedings Berlin Beamforming Conference BeBeC 2010-08, <http://www.bebec.eu/2010> from 2016-10-05
- [4] www.acoustic-camera.com from 2016-09-27
- [5] Karnatz: Qualitätsmanagement zur Dokumentierung, Auswertung und Fehlerminimierung von Messungen mit der Akustischen Kamera, Bachelorarbeit HAW Hamburg, 2016